

1/32" ply or 1/64" ply Reinforcement
Cut 2

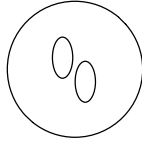

1/32" ply Control H
Cut 4

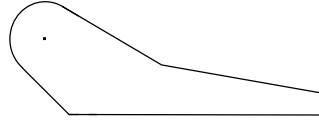



3mm flat carbon reinforcement

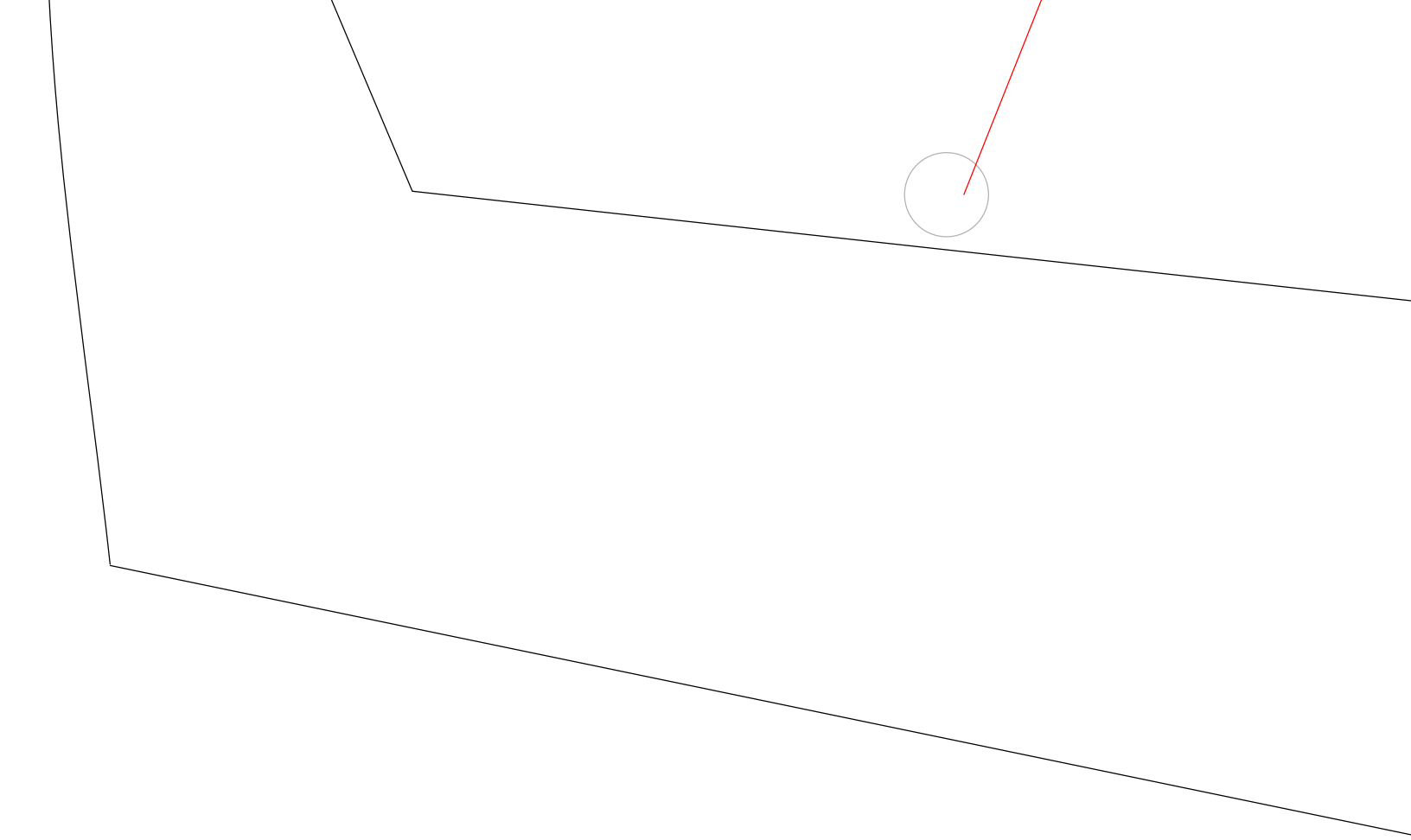

1/32" ply or 1/16" ply Firewall

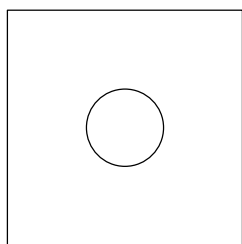

1/32" ply or 1/64" ply Purge

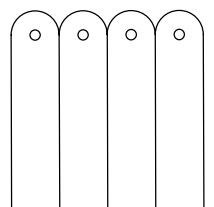



shrod braces

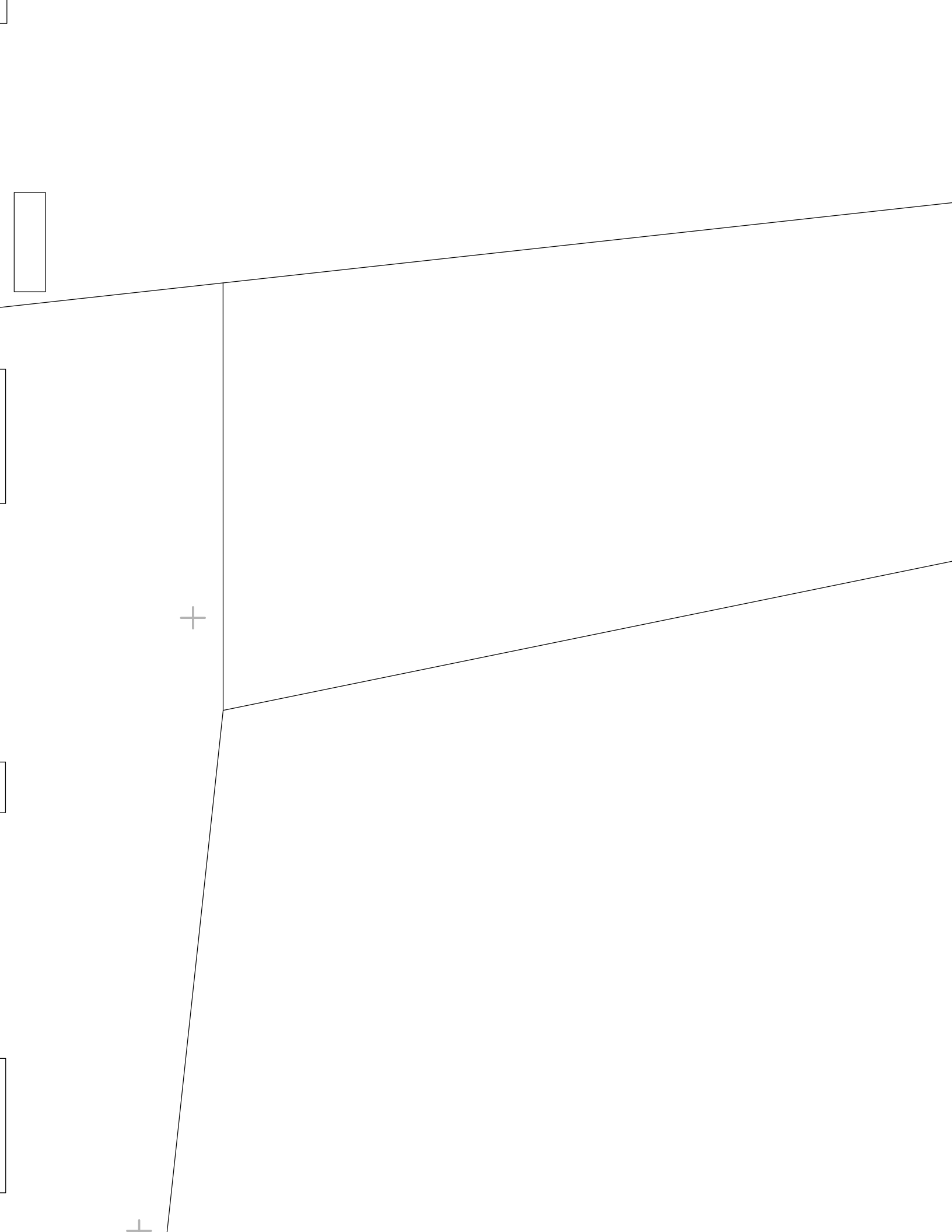

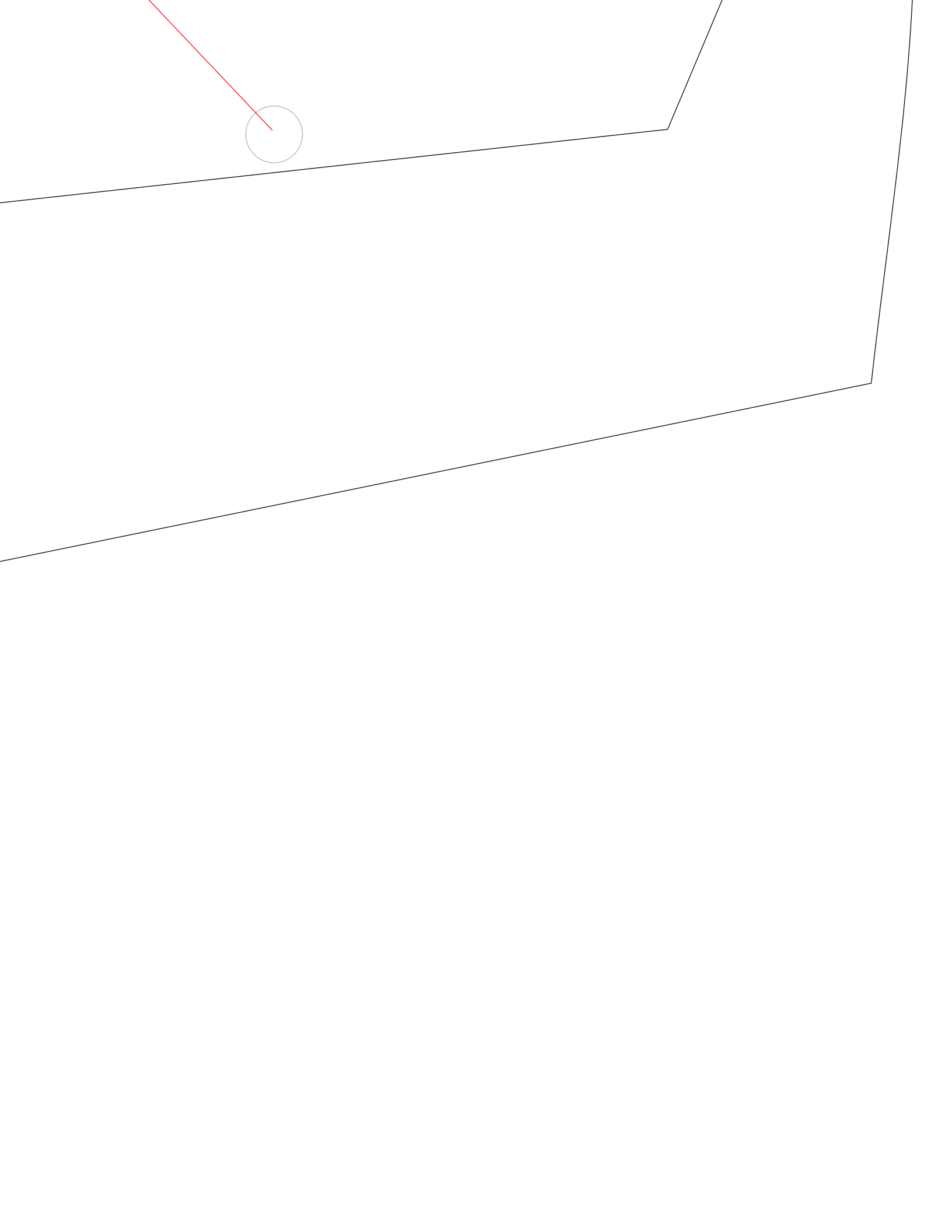

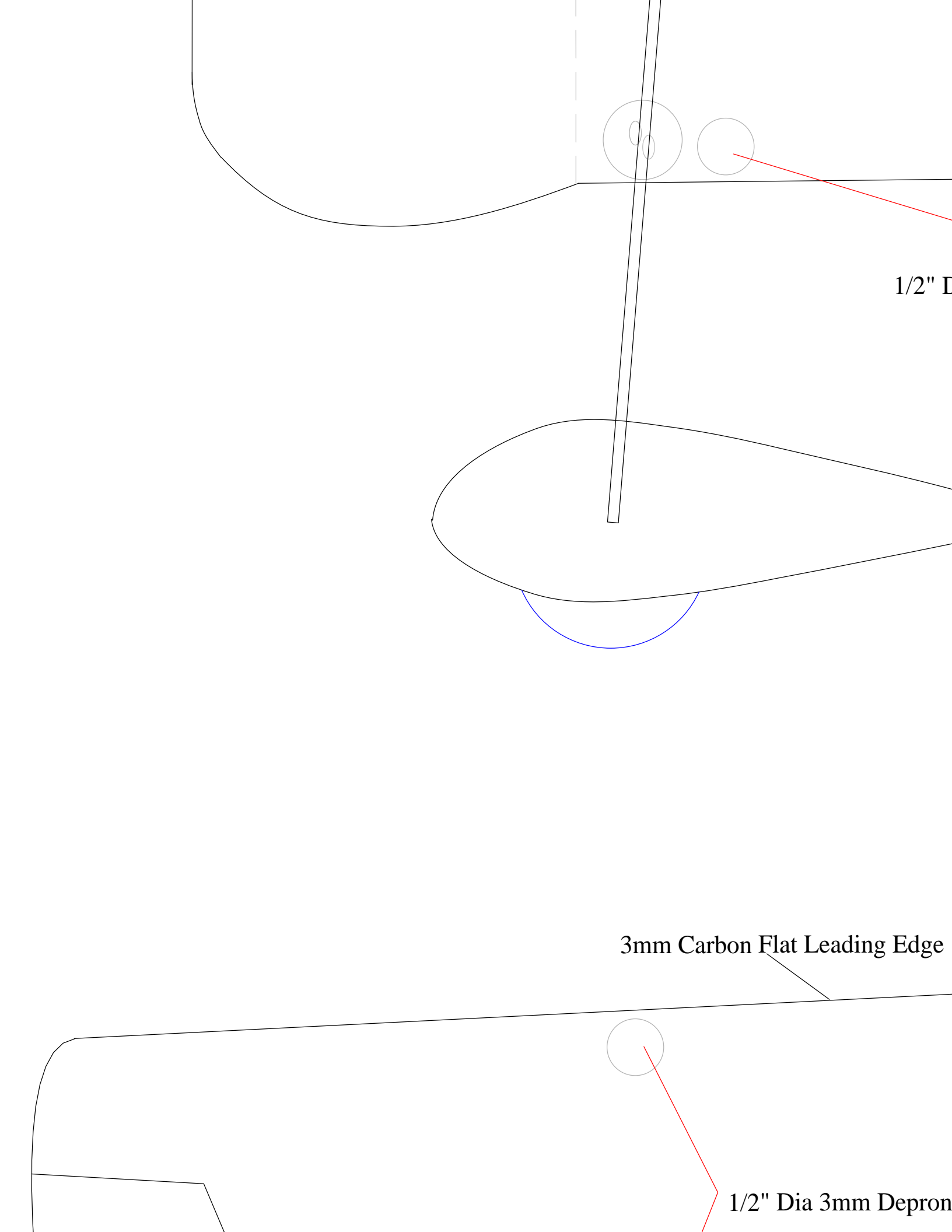

1/2" Dia

3mm Carbon Flat Leading Edge

1/2" Dia 3mm Depron

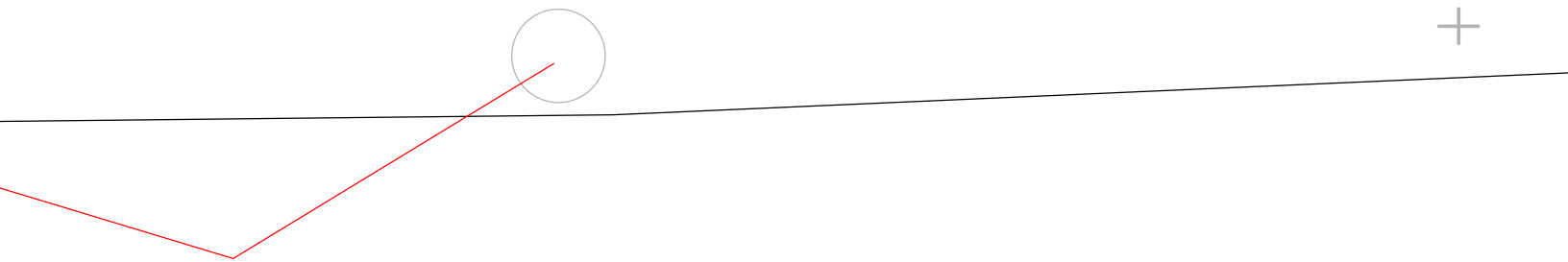

Dia 3mm Depron foam circle both sides

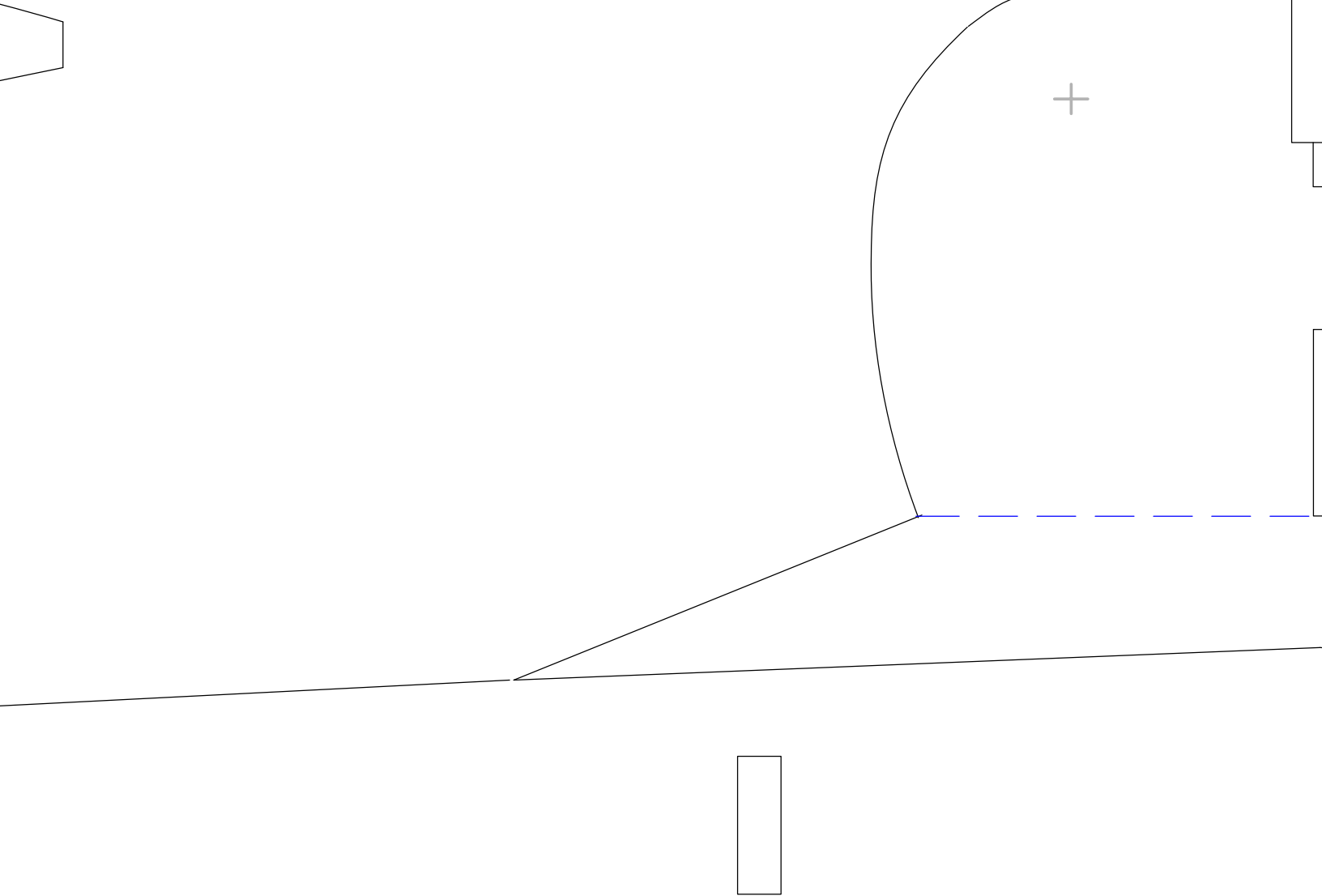

foam circle both sides



Plan Details

Cut all black lines.

Blue lines are just for scale n

Grey lines/shapes indicate ac

Grey crosses indicate carbon





Scrap Carbon Tail Skid

representation.
additions to depron airframe.
bracing locations.



Ham circle both sides

Matcher

Designed by Jeremy Chinn 10-30-2007 Copyright 2007
This plan is free for your own usage. Usage for commercial purposes

Wingspan 33.38"
Length 31.23"

Finished RTF Weight - 144grams/5ozs Unmilled

4 Servo Setup for Dymond 4.7's or equivalent.
Axi 2203-46, Castle TB9 and APC 7x3.8 for power
2s1p 300-400mah battery packs

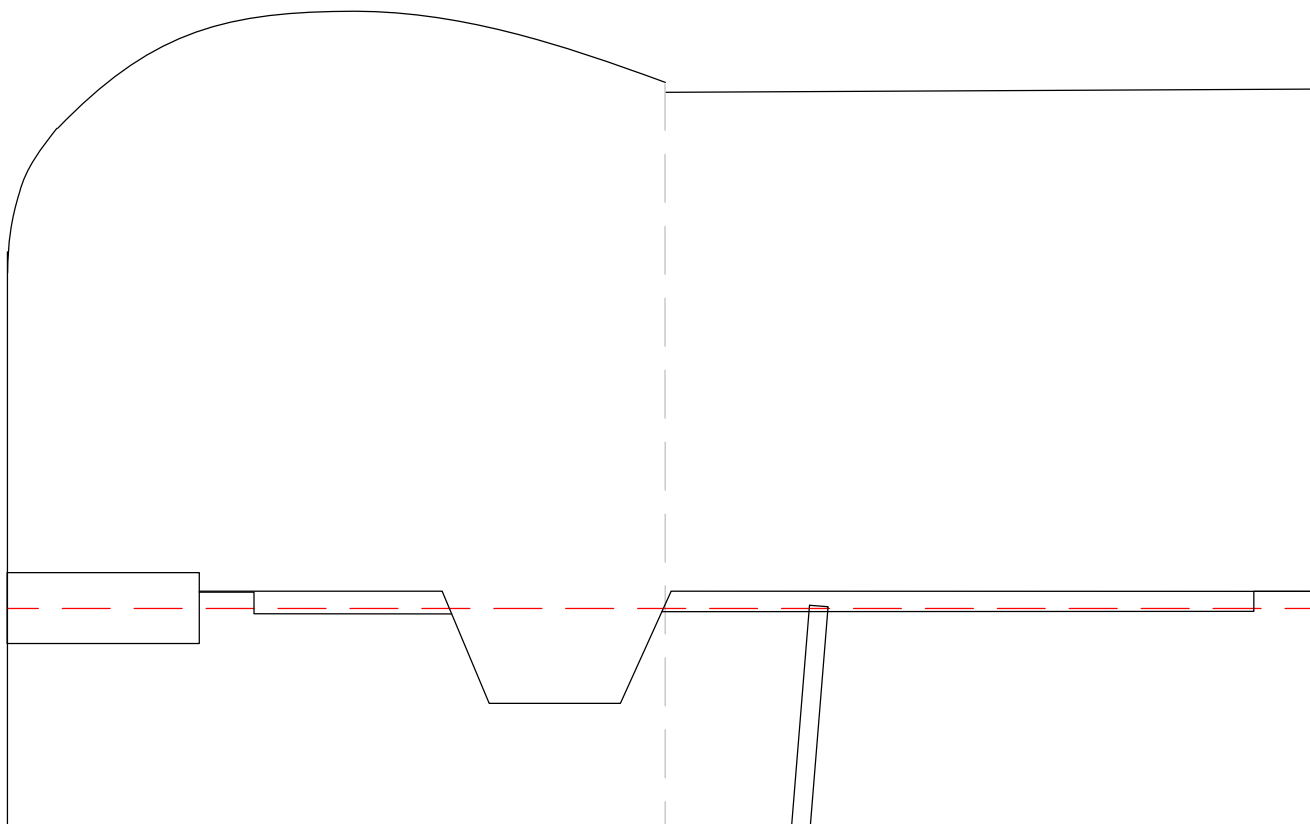

Wholesome Fun

Wholesome Fun is prohibited.

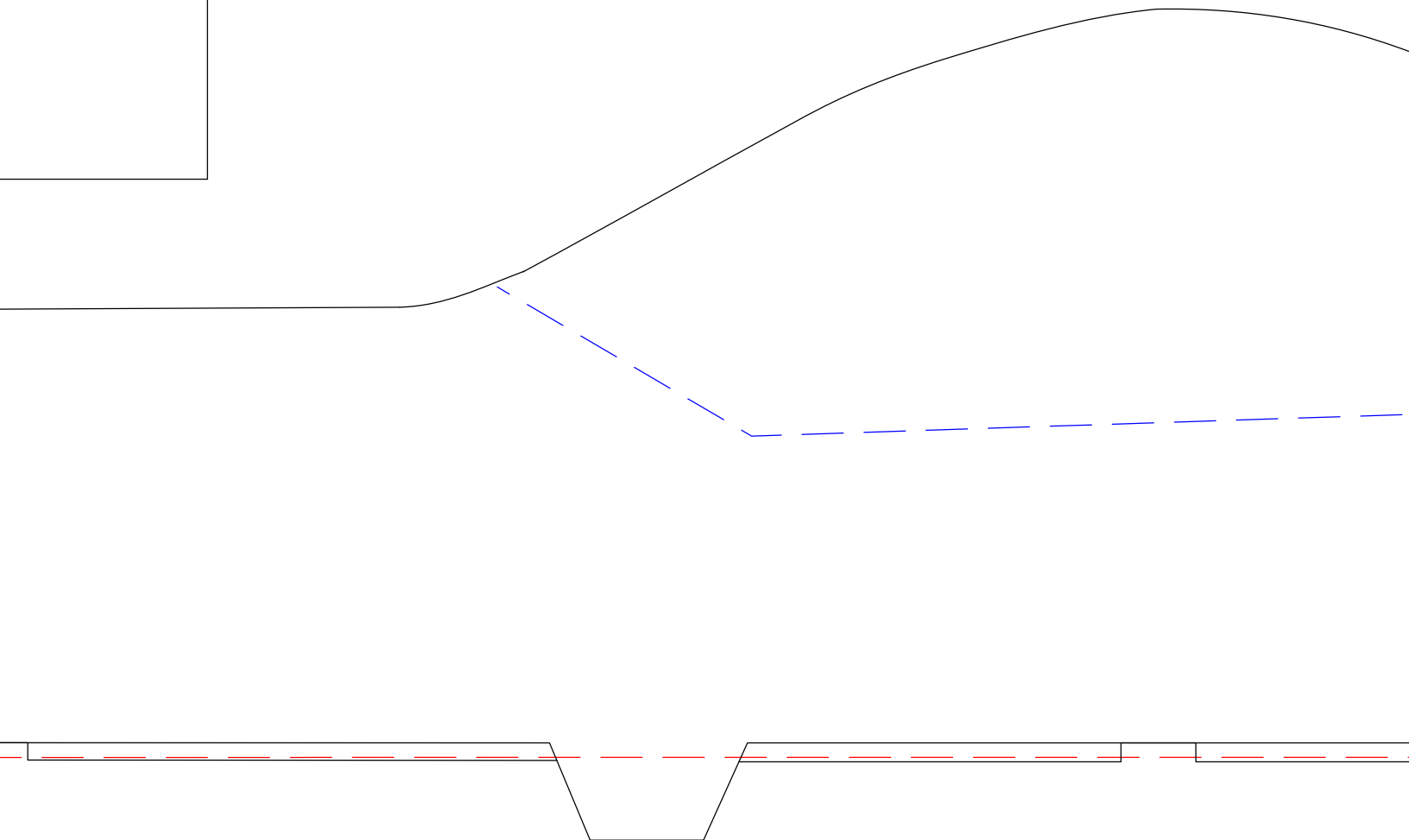

ka Foam

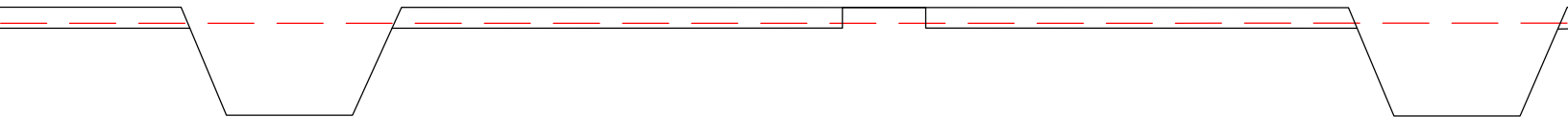
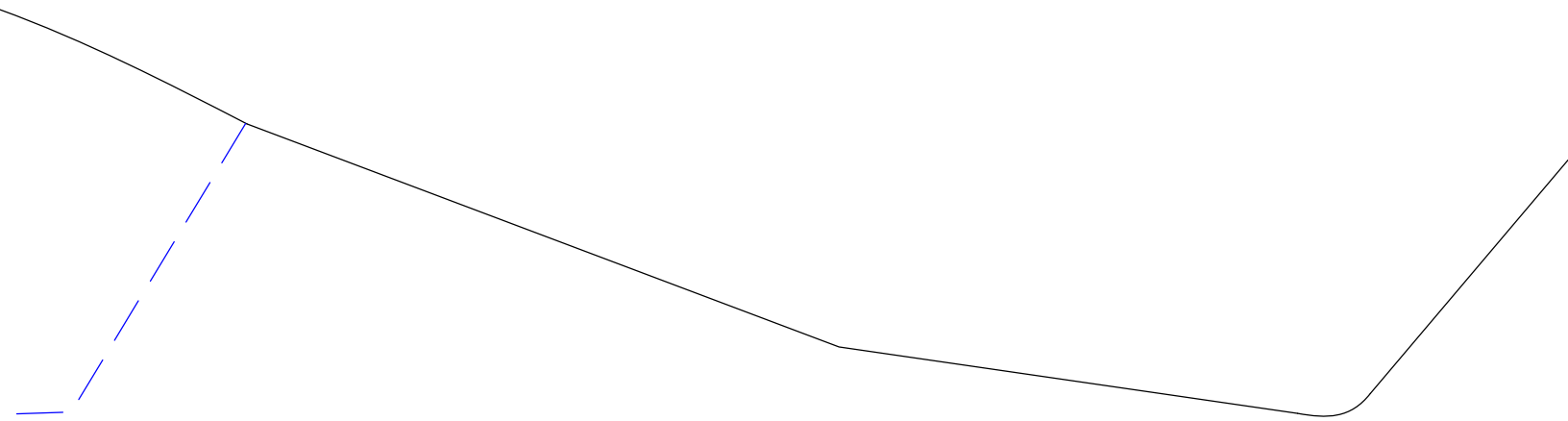

ny

